

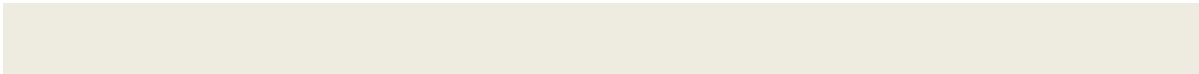

DG H LDI G C ., L D.



C . D D D A

DG H LDI G C ., L D.

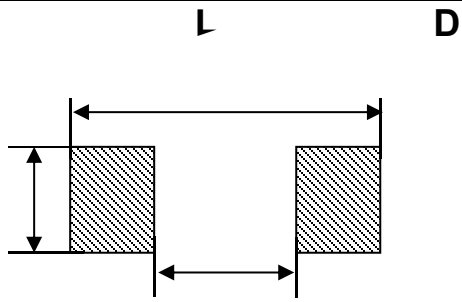

- 
- 

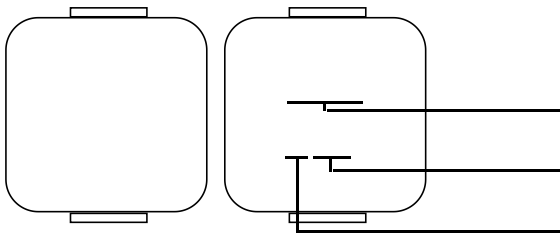

.	I		DC ( )		C	H
	$\mu$				I (A .)	I (A .)

:

:

( ),

( )

I

. DC C

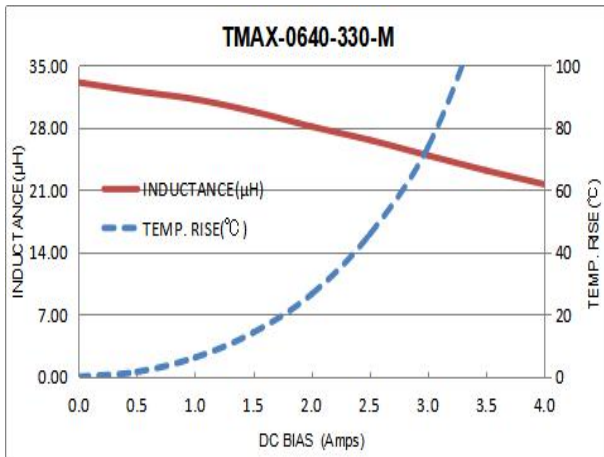
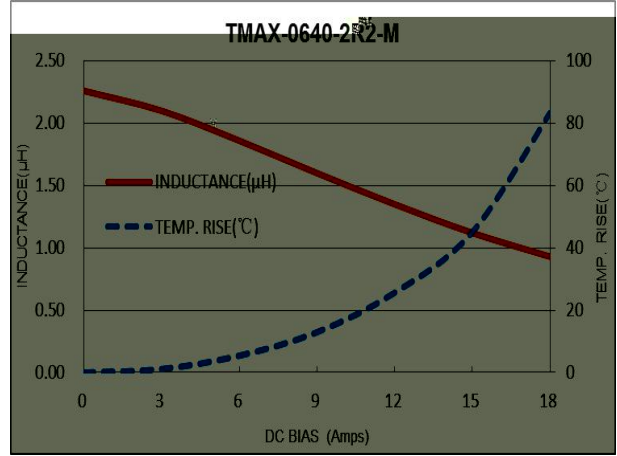
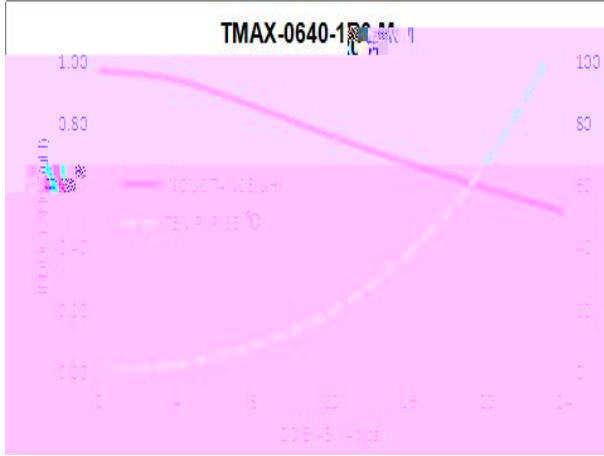

TDG

COHEDI

”

±

± °C ±

±



:

I		
	$\pm$ $\pm$ $\rightarrow$ $\rightarrow$ $\pm$ $\pm$ $\rightarrow$	
	$\pm$	$\pm$
	$\pm$	
	$\pm$	
	$\pm$	

**D**

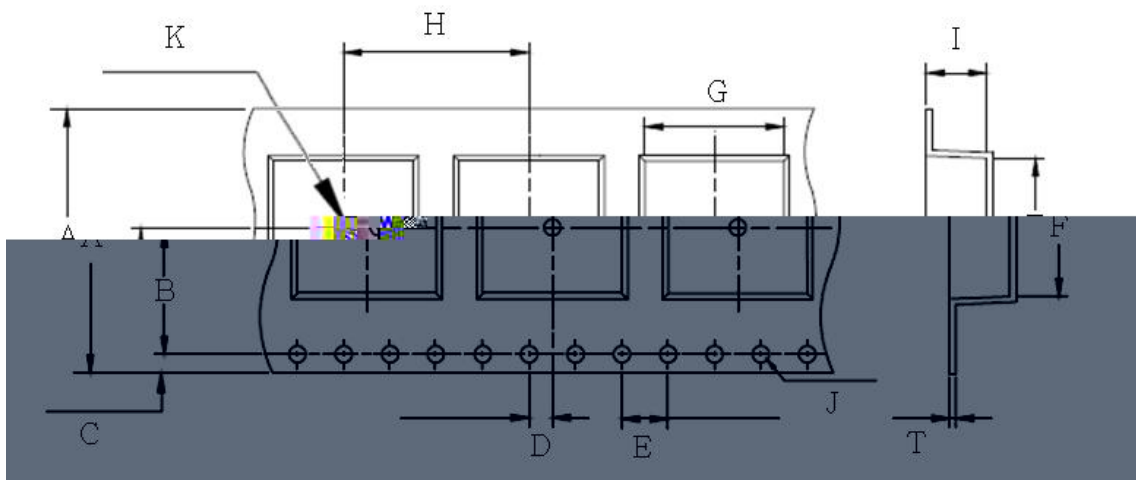

±	±	±	±	±	±
±	±	±	±	±	±

**D**

±	±	

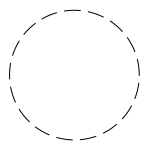

- 
- 

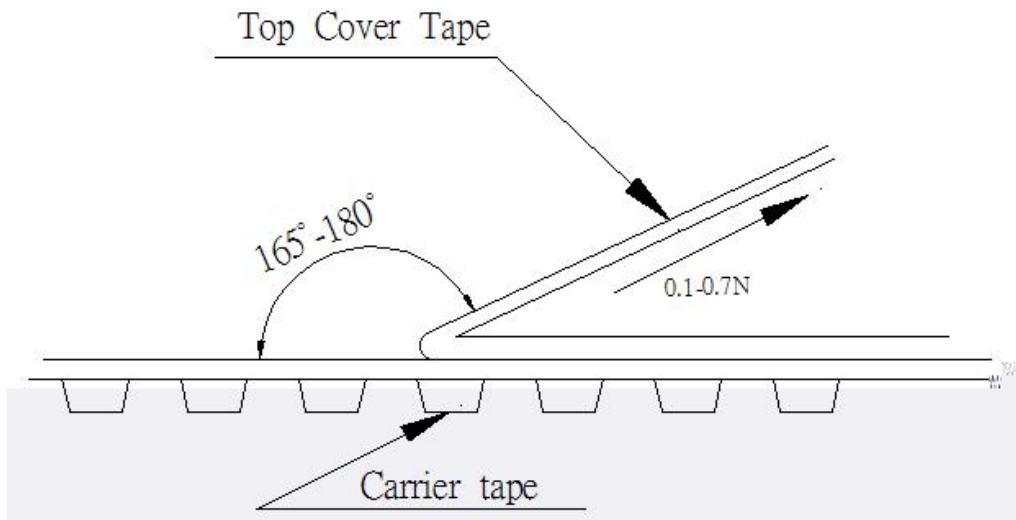



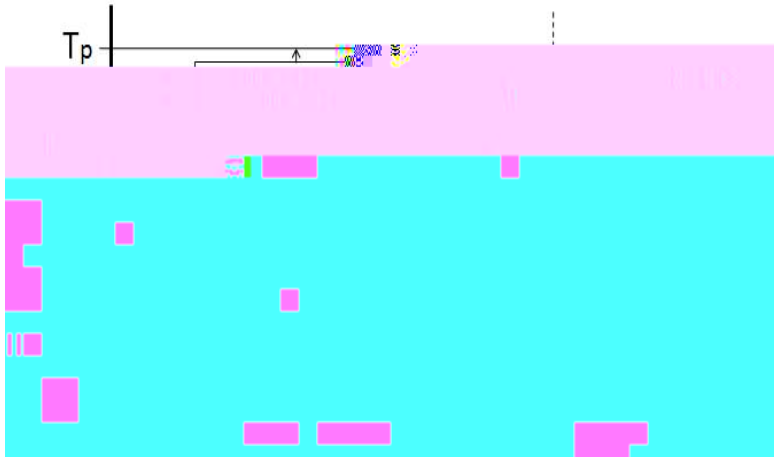

**1- ( )**

	<sup>3</sup> <b>&lt;350</b>	<sup>3</sup> <b>≧350</b>
<	°C	°C
≧	°C	°C

**2-L ( )F ( )**

	<sup>3</sup> <b>&lt;350</b>	<sup>3</sup> <b>350-2000</b>	<sup>3</sup> <b>&gt;2000</b>
<	°C	°C	°C
	°C	°C	°C
	°C	°C	°C

**JDEC J- D-020( )**

<b>F</b>		<b>L ( )F</b>
	°C	°C
	°C	°C
	°C	°C
	°C	°C
°C		
	°C	°C
°C		

●

L

●

●

L

L

✓

✓

✓

✓

✓

✓

✓

✓

✓

✓

C

C

➤

➤

✓

✓

✓

✓

➤

➤ D

**C**

➤

➤

➤

➤

➤

➤

➤